

User Manual

DS-320P-A1

Digital Signage Monitor



About This Document

No part of this publication may be reproduced, transmitted, transcribed, stored in a retrieval system, or translated into any language or computer language, in any form or by any means, including, but not limited to, electronic, magnetic, optical, chemical, manual, or otherwise without prior written permission of MicroTouch™ a TES Company.

The information in this document is subject to change without notice. MicroTouch™ a TES Company makes no representations or warranties with respect to the contents herein, and specifically disclaims any implied warranties of merchantability or fitness for a particular purpose. MicroTouch™ a TES Company reserves the right to revise this publication and to make changes from time to time in the content hereof without obligation of MicroTouch™ a TES Company to notify any person of such revisions or changes. Windows is a registered trademark of Microsoft, Inc. Other brand or product names are trademarks of their respective holders.

Compliance Information

For FCC (USA)

This equipment has been tested and found to comply with the limits for a Class A digital device, pursuant to part 15 of the FCC Rules. These limits are designed to provide reasonable protection against harmful interference when the equipment is operated in a commercial environment. This equipment generates, uses, and can radiate radio frequency energy and, if not installed and used in accordance with the instruction manual, may cause harmful interference to radio communications. Operation of this equipment in a residential area is likely to cause harmful interference in which case the user will be required to correct the interference at his own expense.

This device complies with part 15 of the FCC Rules. Operation is subject to the following two conditions: (1) this device may not cause harmful interference, and (2) this device must accept any interference received, including interference that may cause undesired operation.

For IC (Canada)

CAN ICES-3(A)/NMB-3(A)

For CE (EU)

The device complies with the EMC Directive 2014/30/EU and Low Voltage Directive 2014/35/EU

Warning:

This is a class A product. In a domestic environment this product may cause radio interference in which case the user may be required to take adequate measures.

Renseignements relatifs à la conformité

Pour la FCC (États-Unis).

Ce matériel a fait l'objet d'essais qui ont déterminé qu'il respectait les limites d'un appareil de classe A selon la partie 15 des règlements de la FCC. Ces limites sont établies pour assurer une protection raisonnable contre les parasites nuisant à un fonctionnement dans un environnement commercial. Ce matériel génère, utilise et peut émettre des ondes radio électriques, et lorsqu'il n'est pas installé et utilisé selon le manuel d'instructions, peut causer des parasites nuisant aux communications radio. L'utilisation de ce matériel dans une zone résidentielle est susceptible de causer des parasites auquel cas l'utilisateur est tenu de corriger le problème des parasites à ses propres frais.

L'appareil respecte la partie 15 des règlements de la FCC. Le fonctionnement doit respecter les deux conditions suivantes : 1) cet appareil ne doit pas causer de parasites et (2) cet appareil doit accepter tous les parasites reçus, notamment ceux pouvant causer un fonctionnement non voulu.

Pour Industrie Canada

Norme canadienne NMB-3(A)





Pour la CE (UE)

L'appareil respecte la directive 2014/30/UE relative à la compatibilité électromagnétique et la directive 2014/35/EU sur les limites de basse tension

Avertissement :

Ceci est un produit de classe A. Dans un environnement résidentiel ce produit peut causer des parasites radio auquel cas l'utilisateur peut être tenu de prendre les mesures nécessaires.

Usage Notice

-  **Warning - To prevent the risk of fire or shock hazards, and do not expose the product to moisture.**
-  **Warning - Please do not open or disassemble the product as this may cause electric shock.**
-  **Warning - Power cord shall be connected to a socket-outlet with earthing connection.**
-  **Warning - The cable cover cannot be removed under normal use conditions.**
-  **Warning - Stability Hazard. The touch monitor may fall, causing serious personal injury or death. To prevent injury, this touch monitor must be securely attached to the wall in accordance with the installation instructions.**

Precautions

Please follow all warnings, precautions and maintenance as recommended in this user's manual to maximize the life of your unit.

Do :

- Turn off the product before cleaning.
- Use a soft cloth moistened with mild detergent to clean the product housing.
- Use only the qualified power adapter that comes with your device.
- Disconnect the power plug from AC outlet if the product is not going to be used for an extended period of time.

Don't :

- Do not use abrasive cleaners, waxes or solvents for your cleaning.
- Do not operate the product under the following conditions:
 - Extremely hot, cold or humid environment.
 - Areas susceptible to excessive dust and dirt.
 - Near any appliance generating a strong magnetic field.

Avis d'utilisation



Mise en garde — Pour prévenir les risques d'incendie ou d'électrocution, ne pas exposer le produit à l'humidité.



Mise en garde — Prière de ne pas ouvrir ou démonter le produit, car cela pourrait entraîner l'électrocution.



Mise en garde – Le cordon d'alimentation doit être branché à une prise pourvue d'une mise à la terre.



Mise en garde – La gaine du câble ne doit pas être retirée en conditions normales d'utilisation.



Mise en garde — Risque de renversement. Le moniteur tactile peut se renverser et causer de graves blessures corporelles, voire la mort. Pour prévenir les blessures, ce moniteur tactile doit être solidement fixé au mur selon les instructions d'installation.

Précautions

Veillez suivre toutes les mises en garde, précautions et entretiens recommandés dans ce manuel d'utilisation pour maximiser la durée de vie de votre unité.

À faire :

- Éteindre l'appareil avant de le nettoyer.
- Utiliser un chiffon humidifié par une solution savonneuse pour nettoyer le boîtier du produit.
- Utiliser uniquement l'adaptateur d'alimentation prescrit pour votre appareil.
- Débrancher l'appareil lorsqu'il n'est pas utilisé pendant une période prolongée.

À éviter :

- Ne pas utiliser de nettoyeurs abrasifs, de cires ou de solvants pour le nettoyage
- Ne jamais utiliser l'appareil dans les conditions suivantes :
 - des conditions environnementales extrêmes (chaud, froid ou humidité)
 - des endroits remplis de poussières et de saletés.
 - à proximité d'appareils produisant un fort champ magnétique.

Table of Contents

Chapter 1	7
1.1 Overview	8
1.2 Feature	8
1.3 Specifications	8
1.4 Block Diagram	9
1.5 Interface Connectors	10
1.5.1 Power Connector	10
1.5.2 Video Signal Connector	10
1.6 Package Overview	12
Chapter 2	14
2.1 About VESA Mount	15
2.1.1 Install the VESA screw	16
2.2 About General Mounting Information	17
2.2.1 Landscape	17
2.2.2 Portrait	17
2.3 On-Screen Display	18
2.3.1 OSD Function Description	20
2.3.2 Timing Table Chart	21
2.3.3 EDID Data	21
2.4 Dimension	22
2.4.1 Front View	22
2.4.2 Side View	22
2.4.3 Rear View	23
Appendix	24

Chapter 1

Product Introduction

1.1 Overview

DS-320P-A1 series supports landscape or portrait and low power consumption at the maximum consumption of 70W. DS-320P-A1 provides application for Interactive whiteboard and digital signage.

1.2 Feature

- VESA mounting holes for various mounting options.
- Multilingual OSD user control
- High Resolution FHD (1920 x 1080)

1.3 Specifications

LCD Touch Panel	
Size	31.5" TFT LCD
Brightness	400 cd/m ² (Non-touch screen) 360 cd/m ² (P-CAP)
Number of Pixels	1920(H) x 1080(V)
Touch Type	P-CAP/ 10 points
Environment	
Power Input	100-240V ~ 1.2A 50/60Hz
Operating Temperature	0°C ~ 40°C
Storage Temperature	-20°C ~ 60°C
Operating Humidity	20% ~ 80% RH, non-condensing
Mounting	VESA 400 mm x 200 mm
Dimension (W x H x D)	476.1mm x 66.8mm x 781.5 mm
Net Weight	15.0 kg
Gross Weight	18.0 kg

1.4 Block Diagram

This section describes the electrical requirements of the monitor. The block diagram in figure 1 illustrates the various electrical sub-systems.

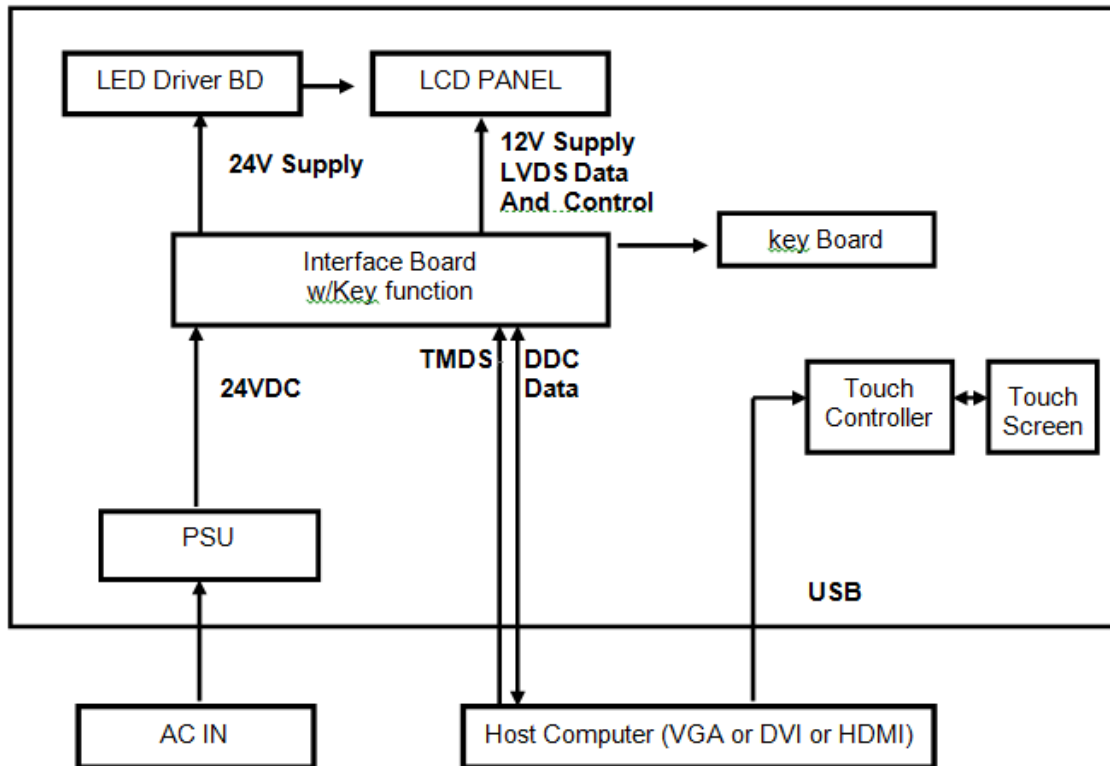

1.5 Interface Connectors



1.5.1 Power Connector

The monitor shall have a power control switch visible and accessible on the bottom of the monitor. The power switch shall be marked with icons per IEC 417, #5009. The operation of the power switch should be programmable thru monitor firmware control.

1.5.2 Video Signal Connector

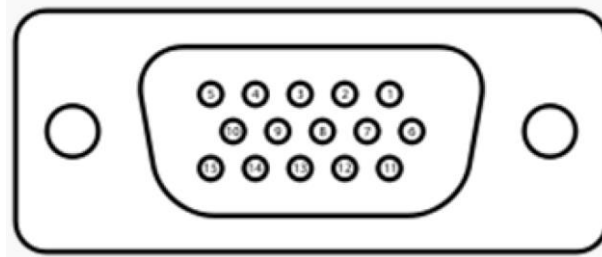

The video signal input via D-type 15-pin female connector.
Connector Pin Assignment:

Pin	Signal
1	Red video signal input
2	Green video signal input
3	Blue video signal input
4	NC
5	DDC ground for the VESA DDC2B function
6	Analog signal ground for the red video
7	Analog signal ground for the Green video
8	Analog signal ground for the blue video
9	+ 5V: Input from host system for the VESA DDC2B function
10	Signal ground
11	NC
12	SDA signal input for the VESA DDC2B function
13	Horizontal signal input from host system
14	Vertical signal input from host system
15	SCL signal input for the VESA DDC2B function

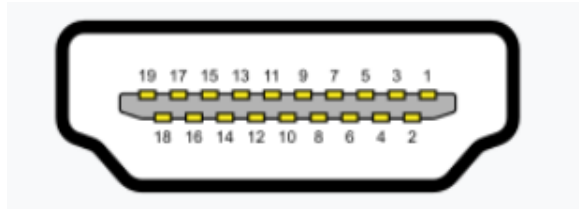

The video signal input via HDMI female connector.
Connector Pin Assignment:



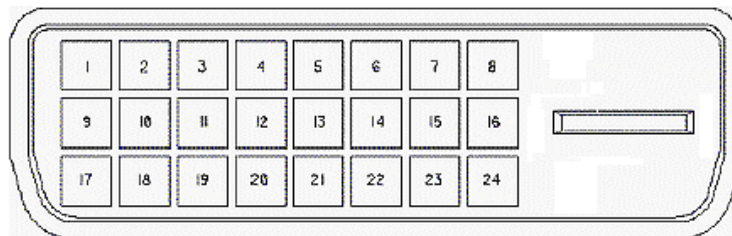



Pin	Signal	Pin	Signal
1	TMDS Data2+	11	TMDS Clock Shield
2	TMDS Data2 Shield	12	TMDS Clock-
3	TMDS Data2-	13	CEC
4	TMDS Data1+	14	Reserved (N.C. on device)
5	TMDS Data1 Shield	15	SCL
6	TMDS Data1-	16	SDA
7	TMDS Data0+	17	DDC/CEC Ground
8	TMDS Data0 Shield	18	+5V Power
9	TMDS Data0-	19	Hot Plug Detect
10	TMDS Clock+		

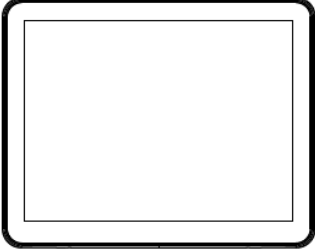
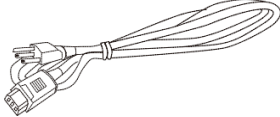
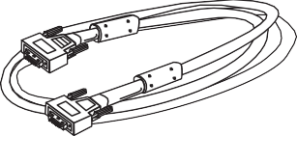
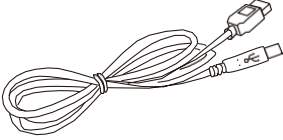

The video signal input via DVI female connector.
Connector Pin Assignment:

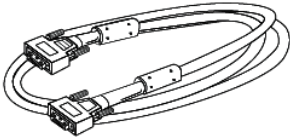
Pin	Signal	Pin	Signal
1	TMDS Data 2-	13	TMDS 3+
2	TMDS Data 2+	14	+5V DDC Power
3	TMDS Data 2/4 Shield	15	Gnd (+5, Analog V/H Sync)
4	TMDS 4	16	Hot Plug Detect
5	TMDS 4	17	TMDS Data 0-
6	DDC Clock	18	TMDS Data 0+
7	DDC Data	19	TMDS Data 0/5 Shield
8	No Connection	20	TMDS Data 5-
9	TMDS Data 1-	21	TMDS Data 5+
10	TMDS Data 1+	22	TMDS Clock Shield
11	TMDS Data 1/3 Shield	23	TMDS Clock+
12	TMDS 3-	24	TMDS Clock-C1

1.6 Package Overview

		
LCD Display	Power Cord	DVI Cable
		
USB Cable (A to B)	HDMI Cable	VGA cable
		
Washer x 2	Nut x 2	Screw (M5 x 8mm) x 4 pcs

 **Warning!**

This product is intended to be supplied by a AC-in Power source, rated 100V~240V, 1.2A 50/60Hz minimum, Tma = 40 degree C minimum, and the altitude of operation = 3048m minimum. If it needs further assistance with purchasing the power source, please contact to MicroTouch for further information.

 **Mise en garde!**

Cet appareil est conçu avec une alimentation de courant CA, d'une tension nominale de 100 V~240 V, 1,2A 50/60 Hz minimum, Tma = 40 degrés C minimum et l'altitude de l'utilisation = 3048 m minimum. Pour d'autres conseils pour l'installation de la source d'alimentation, communiquer avec MicroTouch pour de plus amples renseignements.

Chapter 2

Product Installation

2.1 About VESA Mount

The DS-320P-A1 series conform to the “VESA Flat Display Mounting Interface Standard” which defines a physical mounting interface for touch monitor and corresponding with the standards of touch monitor mounting devices. The VESA mount is located on the back of this unit.

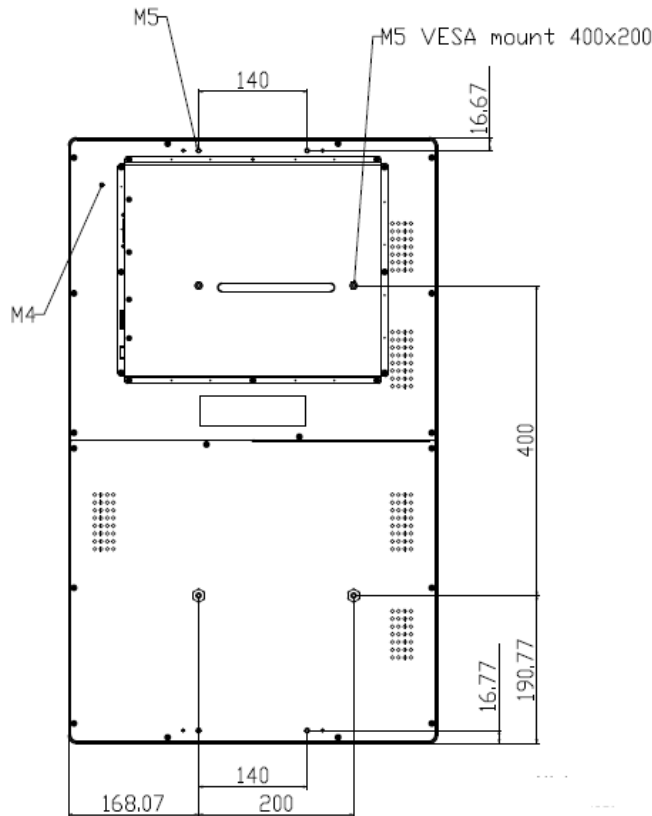

Warning!

*Please select the MicroTouch original screws!
The distance between the back cover surface and the bottom of the screw hole is 6~7 mm. Please use M5 screws diameter with proper length to mount your monitor.*

Note: The mounting stand must be able to support at least 33 lbs (15.0 Kg).

Mise en garde!

*Sélectionner les vis d'origine de MicroTouch!
La distance entre la surface du couvercle arrière et le bas de l'orifice de la vis est de 6 ~7mm. Utiliser les vis M5 de diamètre pour le montage de votre moniteur.*

Remarque : Le support de montage doit pouvoir supporter un poids d'au moins 33 lb (15,0kg).

2.1.1 Install the VESA screw

Note: Please install/ dismantle the product when the device is in the shutdown state.

Step 1: Fasten two M5 screws nut into the VESA hole

The length of screw nut is 30mm

Step 2: Fasten four M5 screws into the VESA hole

The specification of screw is M5 x 8mm

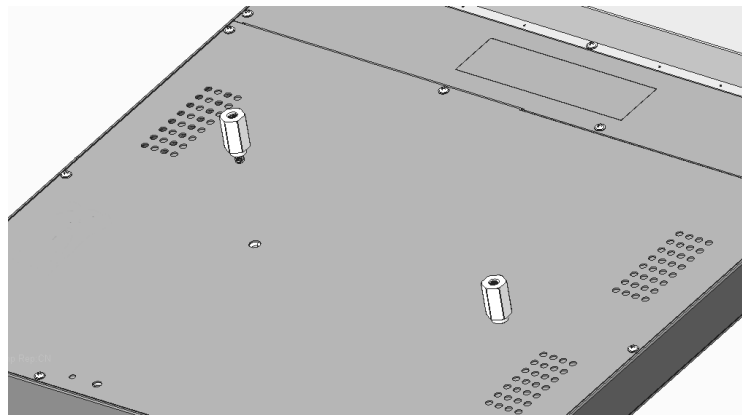
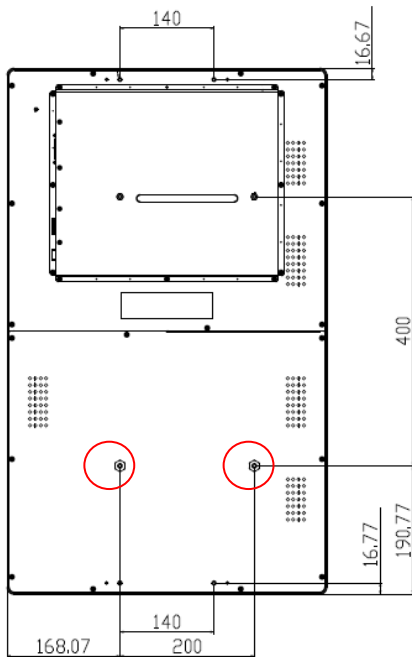

2.2 About General Mounting Information

The following two mounting orientations are supported: Landscape and portrait mode. For optimal touch performance, ensure that the monitor is supported fully and is as flat as possible.

2.2.1 Landscape

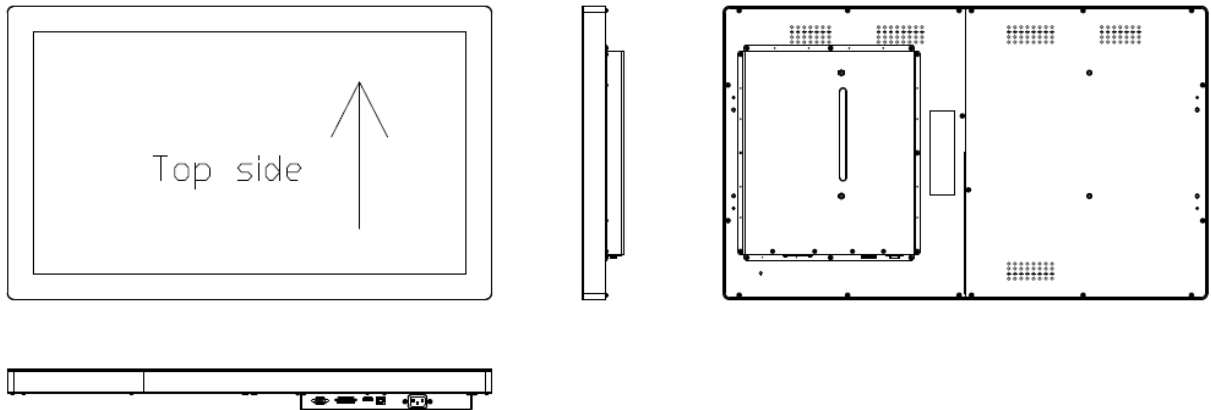

2.2.2 Portrait

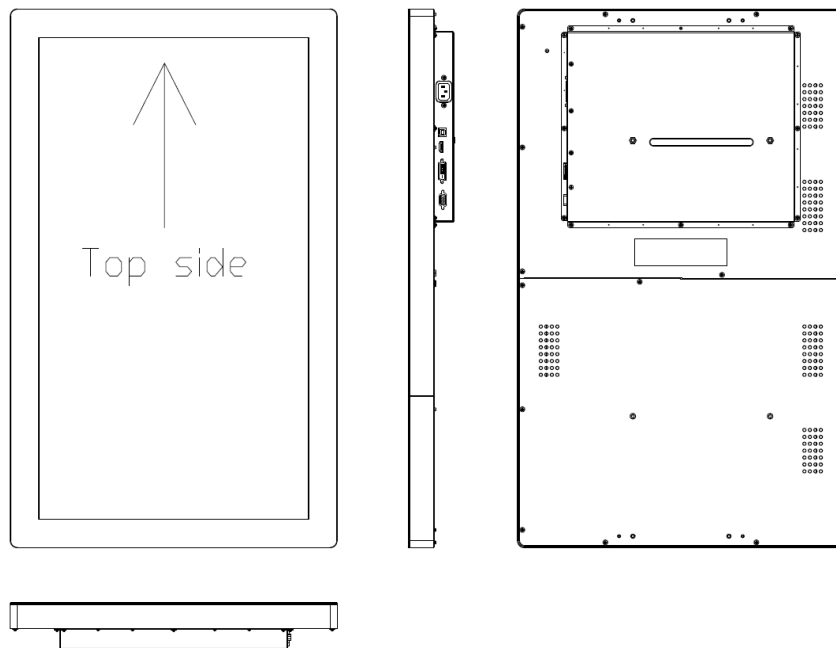

2.3 On-Screen Display



The OF-320P-A1 provide side panel controls. And the following is OSD function table:

Key \ OSD	Menu off status	Menu on status
MENU	Menu appear	Menu disappear/ return to main item
▲	Brightness	Main item select up/ Adjust up
▼	Contrast	Main item select down/ Adjust down
SELECT	Auto Adjusting	Enter/Select sub-item function
⏻	Power On/Off	

1. Press the “MENU” button to pop up the “on-screen menu” and press “Up” or “Down” button to select among the five functions in the main menu.
2. Press “SELECT” to enter the sub menu , and then use “Up” or “Down” button to select the adjustable functions.
3. Choose the adjustment items in the sub menu by pressing the “SELECT ” button.
4. Adjust the value of the adjustment items by pressing the “Up” or “Down” button.
5. With the OSD menu on screen, press “Menu” button to return main menu or exit OSD.
6. The OSD menu will automatically close, if you have left it idle for a pre-set time.
7. To Lock the OSD / Power menu buttons, please follow the instructions below.

(Please note: the monitor has to be turned ON with a valid signal pre-set)

 - a. Without the OSD menu on screen, press and hold “Menu” key ,and press “POWER” once then release “MENU” key. The “Lock/Unlock” menu will appear for 5 seconds.
 - b. Use the "UP" and “DOWN key to select OSD or Power setting then set at “Lock” (or “Unlock”) by pushing the "ENTER" button.
 - c. When pressing “MENU” button , the previous setting will be saved and exit the “Lock/Unlock” menu automatically.

Please note:

1. When the OSD Lock function is selected, this indicates that all the buttons except "power" button are now disabled.
2. When the Power Lock function is selected, this indicates that the power key is disabled; user can not to turn off the monitor by "Power" key.
3. How to enter factory OSD menu, please follow the instructions below.
 - a. Without the OSD menu on screen, press and hold "Menu" key ,and press "UP" once then release "MENU" key. The factory menu will appear on the screen.
 - d. Use the "UP" and "DOWN key to select main functions, then press "SELECT" to enter sub menu for adjusting (or setting) those values.
 - c. Select "GoTo Main" and press "SELECT" to exit factory OSD menu, it will automatically switch to user menu for normal OSD operation.
4. In power saving status, to press "Menu" button can wake up OSD for selecting video port.

2.3.1 OSD Function Description

Item	Content	Default
Contrast	The monitor luminance level control.	50
Brightness	The monitor backlight level control.	50
Auto Adjust	Automatically adjusts the screen image of VGA signal, affecting the H-position, V-position, Frequency, and Phase menu.	NA
Left/Right	Moving screen image horizontal position to left or right.	NA
Up/Down	Moving screen image vertical position to up or down.	NA
Horizontal size	The screen image horizontal dot clock adjustment.	NA
Fine	The screen image pixel phase adjustment.	NA
OSD Left/Right	Moving OSD menu horizontal position to left or right.	50
OSD Up/Down	Moving OSD menu vertical position to up or down.	50
OSD Time out	OSD auto-disappear time selection.	15
OSD Language	OSD menu language selection. (English, French, Deutsch, Italian, Spanish, Japanese , Simplified Chinese and Korean)	English
Factory Reset	Factory default value restored.	NA
Color Temperature	Color temperature selection. (5500K, 6500K, 7500K, 9300K, User; default: User)	USER
Red	Red gain of selected color temperature. (only User mode can be adjusted)	97
Green	Green gain of selected color temperature. (only User mode can be adjusted)	100
Blue	Blue gain of selected color temperature. (only User mode can be adjusted)	97

2.3.2 Timing Table Chart

Mode	Resolution	H-Freq. (KHz)	Bandwidth (MHz)	Polarity	
				H	V
1	VGA 640x480@ 60Hz	31.47	25.175	-	-
2	VESA 800x600@ 56Hz	35.16	36	+	+
3	VESA 800x600@ 60Hz	37.88	40	+	+
4	VESA 1024x768@ 60Hz	48.36	65	-	-
5	VESA 1280x720@ 60Hz	44.772	74.5	+	+
6	VESA 1280x768@ 60Hz	47.776	79.5	-	+
7	VESA 1280x1024@ 60Hz	64	108	+	+
8	VESA 1280x960@ 60Hz	60	108	+	+
9	VESA 1440x900@ 60Hz	56	106.5	-	+
10	VESA 1680x1050@ 60Hz	65.2	146	-	+
11	VESA 1920x1080@ 60Hz	67.5	148.5	+	+

2.3.3 EDID Data

The monitor assembly shall provide a display communications channel that conforms to VESA DDC2B hardware requirements. This configuration shall contain the 128-byte EDID file as specified by VESA EDID Standard.

2.4 Dimension

2.4.1 Front View

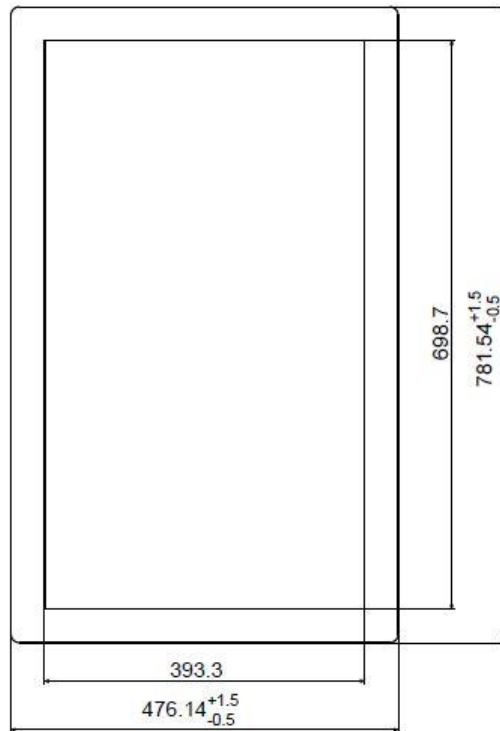

2.4.2 Side View

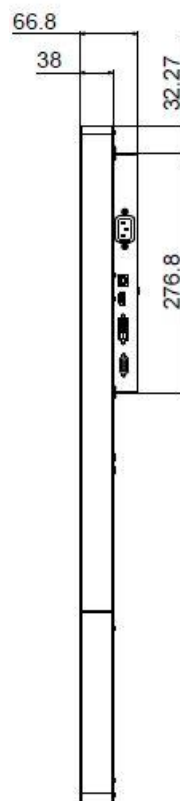

2.4.3 Rear View

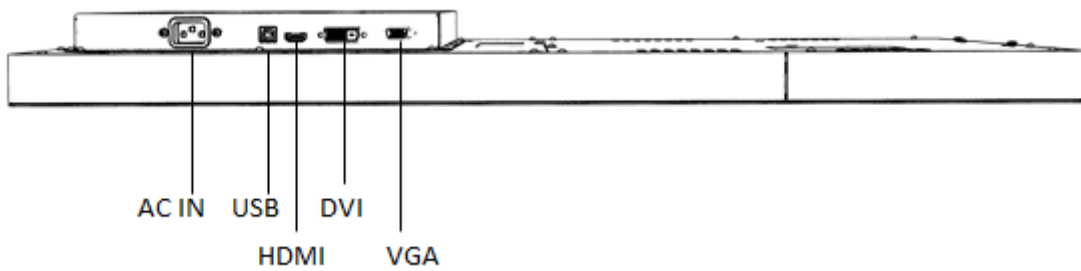
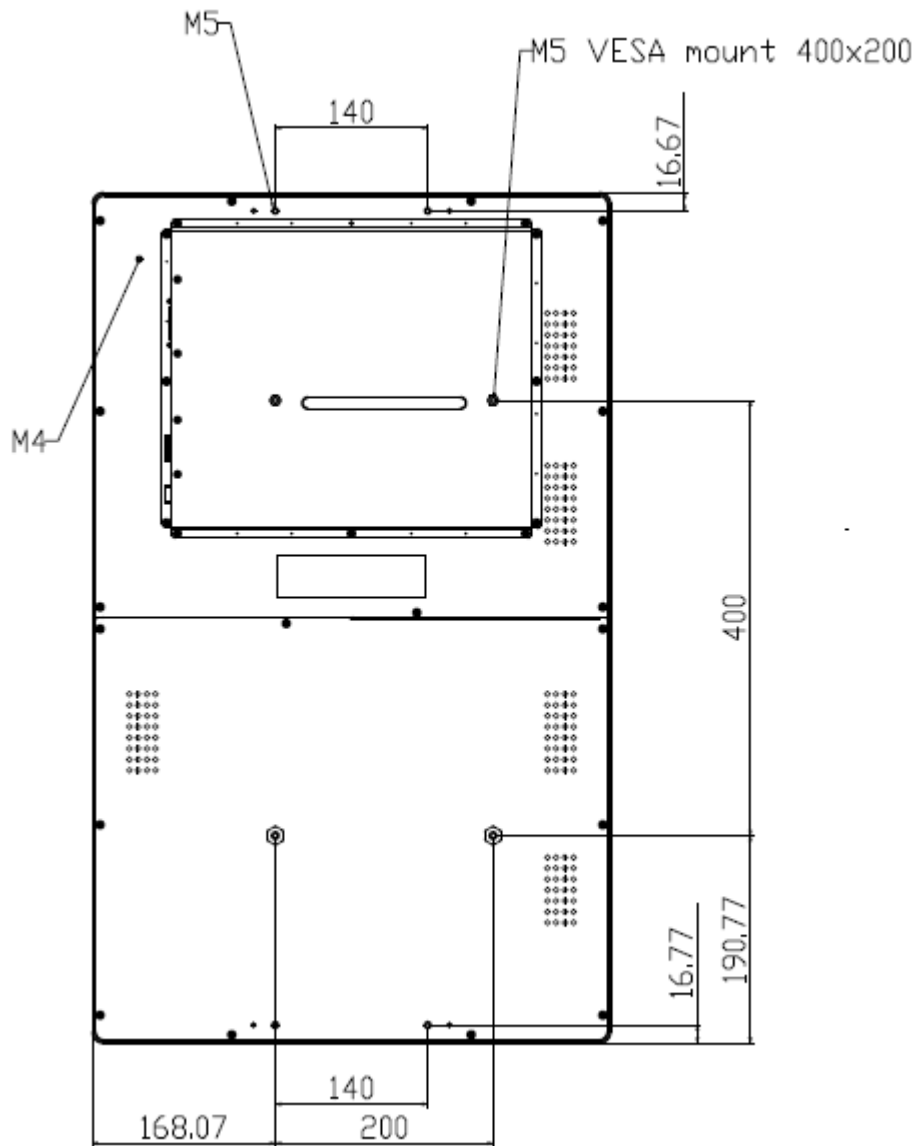

Appendix

Declaration of the Presence Condition of the Restricted Substances Marking

設備名稱：觸控螢幕 型號（型式）：DS-320P-A1 Equipment name：Touch Monitor Type designation (Type)：DS-320P-A1						
單元 Unit	限用物質及其化學符號 Restricted substances and its chemical symbols					
	鉛 Lead (Pb)	汞 Mercury (Hg)	鎘 Cadmium (Cd)	六價鉻 Hexavalent chromium (Cr ⁺⁶)	多溴聯苯 Polybrominated biphenyls (PBB)	多溴二苯醚 Polybrominated diphenyl ethers (PBDE)
塑膠零件 Plastic Parts	○	○	○	○	○	○
金屬零件 Metal Parts	-	○	○	○	○	○
線纜和電纜組件 Cable component	-	○	○	○	○	○
薄膜液晶面板 LCD Panel	-	○	○	○	○	○
觸控式螢幕面板 Touch Panel	-	○	○	○	○	○
電路板 PCBA	-	○	○	○	○	○
軟體(光碟..等) Software	○	○	○	○	○	○
Note 1： “Exceeding 0.1 wt %” and “exceeding 0.01 wt %” indicate that the percentage content of the restricted substance exceeds the reference percentage value of presence condition. ° Note 2： “○” indicates that the percentage content of the restricted substance does not exceed the percentage of reference value of presence. Note 3： The “-” indicates that the restricted substance corresponds to the exemption.						